

目 录

一、运输作业组织与管理模块..... 2

二、仓储与配送作业组织与管理模块..... 34

三、国际物流作业组织与管理模块..... 150

四、 快递物流作业组织与管理模块.....	213
-----------------------	-----

湖南商务职业技术学院物流管理专业学生技能考核题库

一、运输作业组织与管理模块

○

○

○

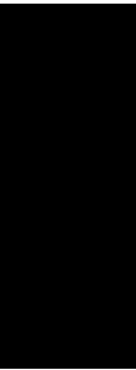
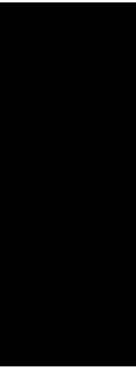

--	--	--

○

○

--	--	--	--	--

() 任务描述

- :
-
-



<input type="checkbox"/> <input type="checkbox"/>				<input type="checkbox"/> <input type="checkbox"/>				
<input type="checkbox"/> <input type="checkbox"/>								
						<input type="checkbox"/> <input type="checkbox"/> <input type="checkbox"/> <input type="checkbox"/>		



() 任务描述:

-
-
-



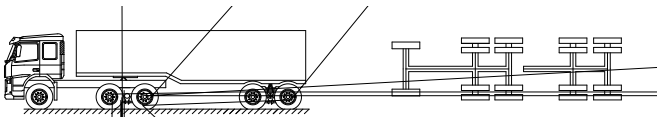

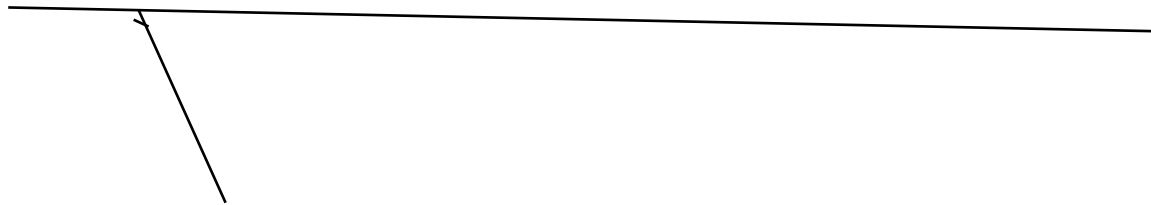
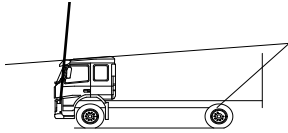
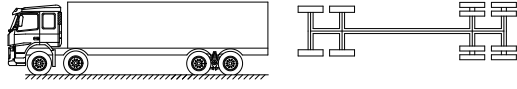
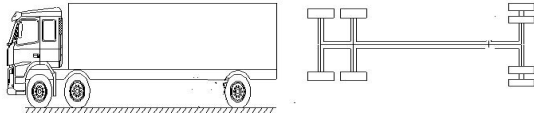

() 任务描述:



○

○

○

○

○

() 任务描述



D

<input type="checkbox"/> <input type="checkbox"/>			<input type="checkbox"/> <input type="checkbox"/>						
<input type="checkbox"/> <input type="checkbox"/>									
						<input type="checkbox"/> <input type="checkbox"/> <input type="checkbox"/> <input type="checkbox"/>			





2

3

4

() 任务描述



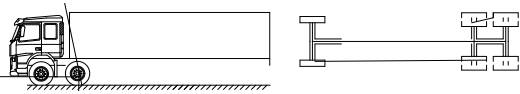
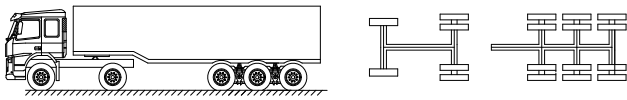
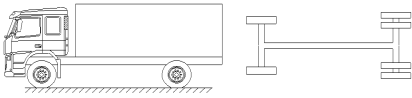



() 任务描述

-
-
-
-
-

() 任务描述

()

()

)	()		

()

()

()

()

()

○

()				

○

Sailing Schedule from : Shenzhen,Shenzhen,Guangdong,China	
To : Los Angeles,Los Angeles,CA,United States	
Origin City : Shenzhen,Shenzhen,Guangdong,China	CY/DOOR
Destination City : Los Angeles,Los Angeles,CA,United States	CY/DOOR

序列号	航线	船名	航次	截关时间	装货港	预计离港时间	实际离港时间	卸货港
1	YPSW	YM UNISON	59E	2016-04-22 17:00	Yantian	2016-04-25		Los Angeles
2	SEA	NORTHERN JAVELIN	002E	2016-04-23 12:00	Yantian	2016-04-27		Long Beach
3	AAS2	CMA CGM LIBRA	095TXE	2016-04-25 16:00	Yantian	2016-04-28		Long Beach
4	YPSW	YM UBIQUITY	22E	2016-04-29 17:00	Yantian	2016-05-02		Los Angeles
5	SEA	C SCL PUSAN	117E	2016-04-30 12:00	Yantian	2016-05-04		Long Beach
6	AAS2	CMA CGM COLUMBA	097TXE	2016-05-02 16:00	Yantian	2016-05-05		Long Beach
7	SEA	COSCO NINGBO	069W	2016-05-06 11:00	Yantian	2016-05-08		Long Beach
8	YPSW	YM JIREBY...	50E	2016-05-06 17:00	Yantian	2016-05-09		Los Angeles
9	SEA	COSCO EXCELLENCE	027E	2016-05-07 12:00	Yantian	2016-05-11		Long Beach
10	AAS2	CMA CGM CENTAURUS	099TXE	2016-05-09 16:00	Yantian	2016-05-12		Long Beach
11	YPSW	YM MASCULINITY	32E	2016-05-13 17:00	Yantian	2016-05-16		Los Angeles
12	SEA	HONG KONG BRIDGE	039E	2016-05-14 12:00	Yantian	2016-05-18		Long Beach
13	AAS2	CMA CGM THALASSA	101TXE	2016-05-16 16:00	Yantian	2016-05-19		Long Beach



干货箱



	箱体内部尺寸			箱体内容积及载重量		箱门开度尺寸	
	L	W	H	Cu	P	W	H
20'	5898	2352	2393	33.2	21740/28230#	2340	2280
40'	12032	2352	2393	67.7	26630	2340	2280
HC	12032	2352	2698	76.3	26520	2340	2585

冷藏箱



	箱体内部尺寸			箱体内容积及载重量	
	L	W	H	Cu	P
20'	5444	2284	2267	28.5	21135/27160#
40'	11583	2284	2250	58.7	26580
HC	11583	2284	2659	67.9	26380

开顶箱

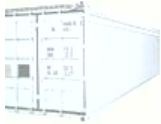

	箱体内部尺寸			箱体内容积及载重量	
	L	W	H	Cu	P
20'	5900	2330	2337	32.6	21740
40'	12025	2330	2337	65.8	26410

○

○

() 实施条件

() 考核时量

() 评分细则

1

() 任务描述



		<input type="checkbox"/>	<input type="checkbox"/>	<input type="checkbox"/>	<input type="checkbox"/>

□		□		
□		□		



() 实施条件

() 考核时量

() 评分细则

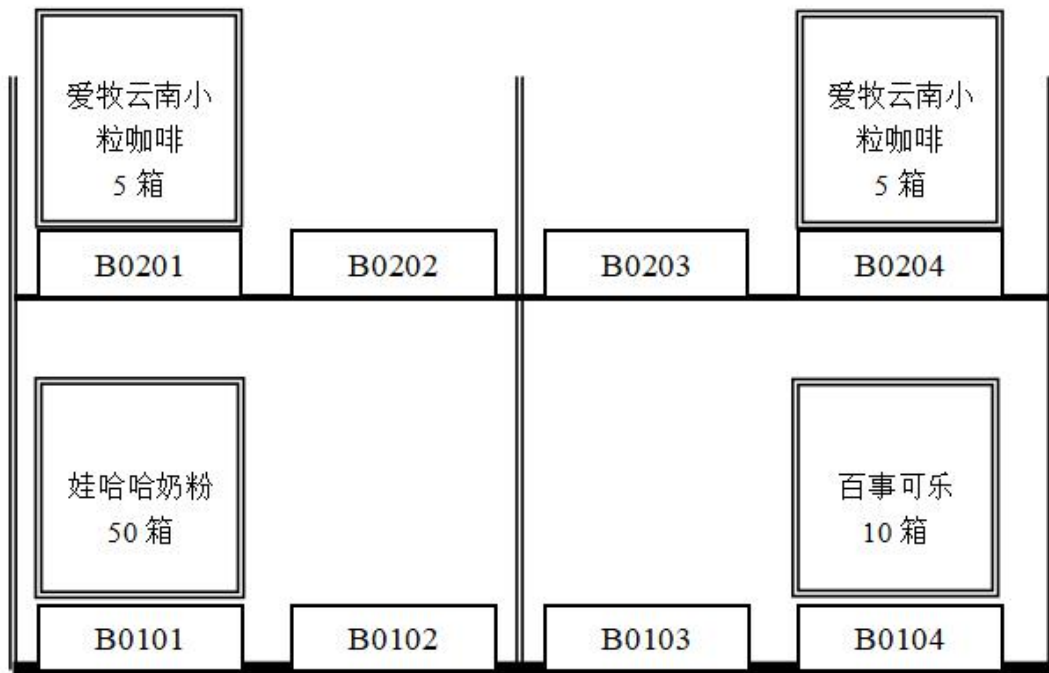

产品运输单

-
-
-
-
-
-
-
-

80				



产品运输单

-
-
-
-
-
-
-
-

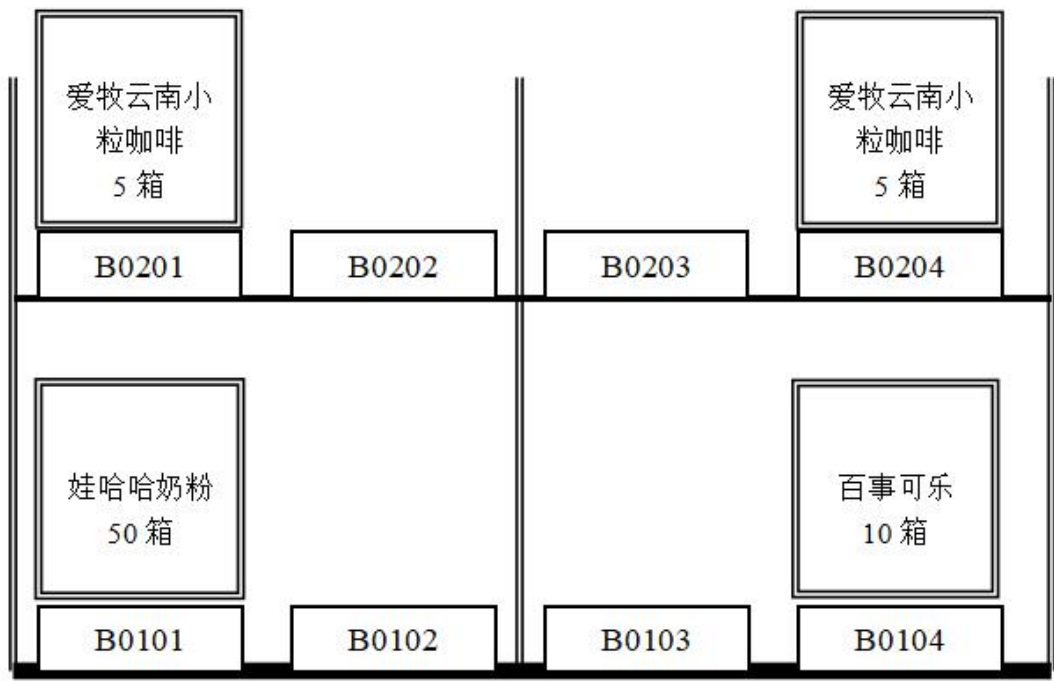

产品运输单

-
-
-
-
-
-
-
-

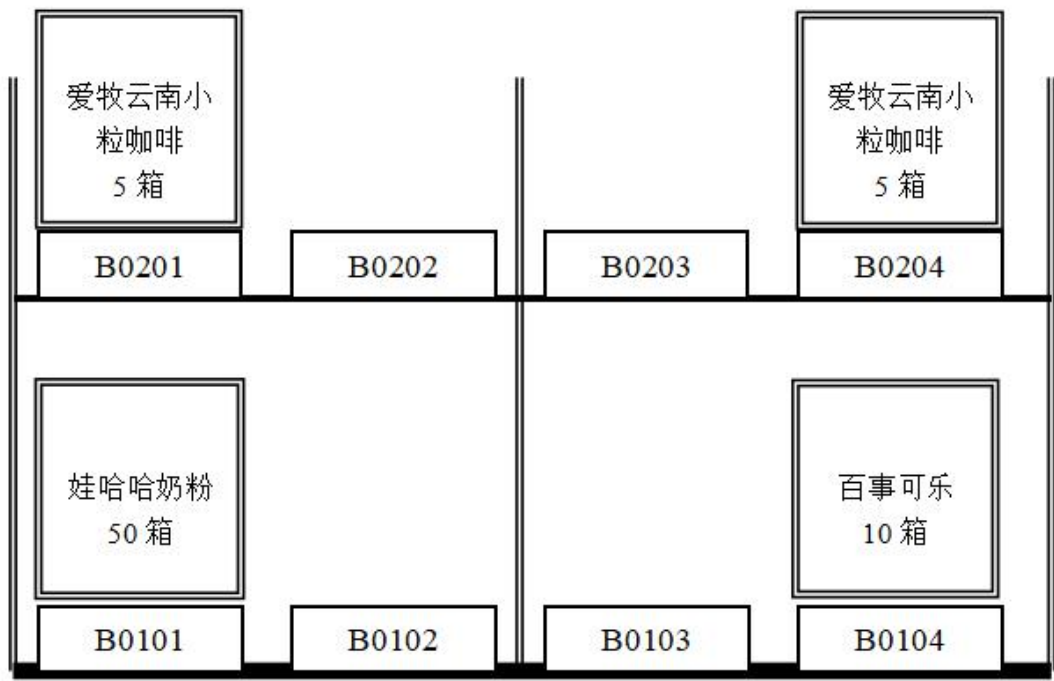

产品运输单

-
-
-
-
-
-
-
-

0 0 0 0 0

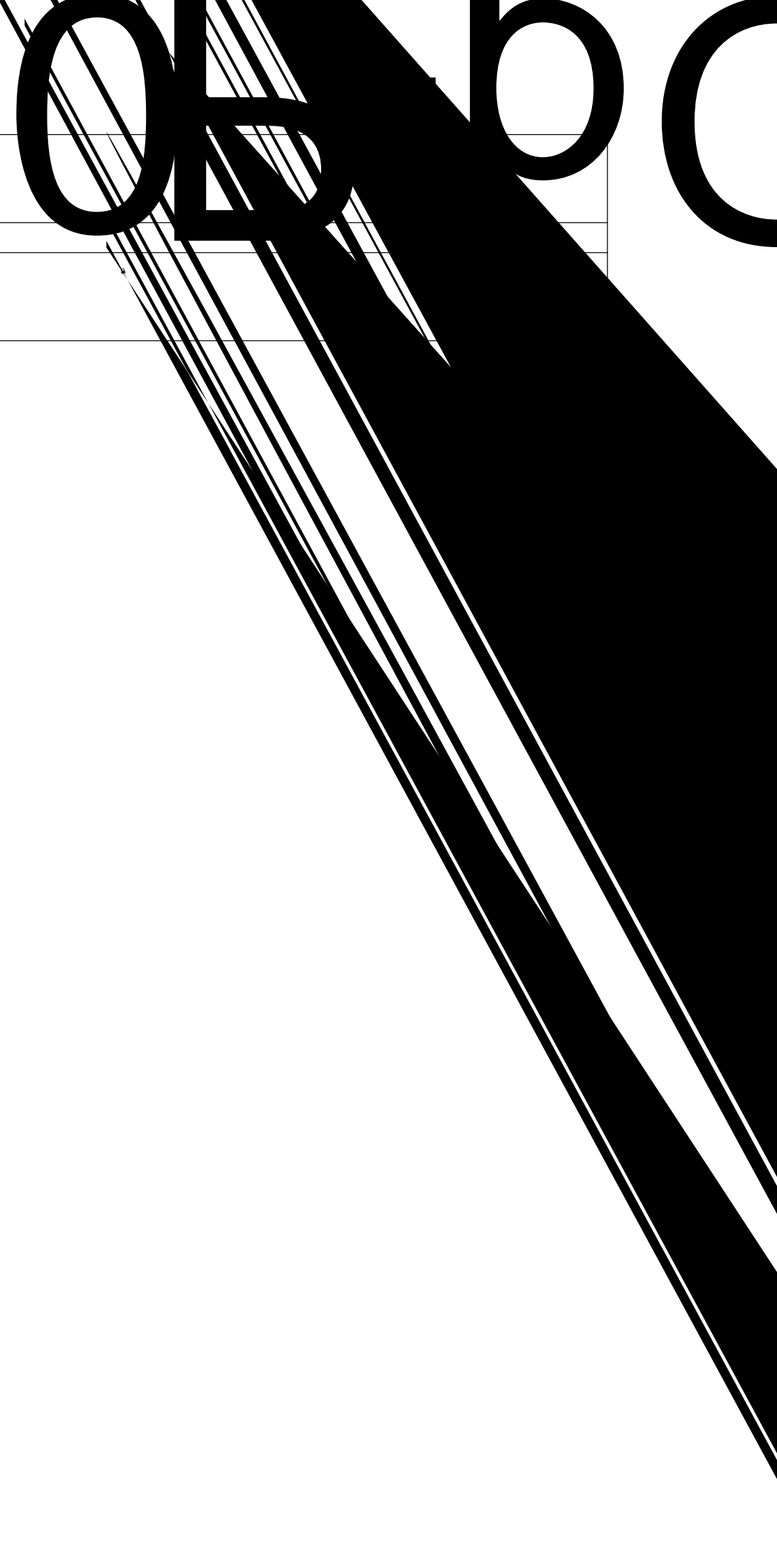

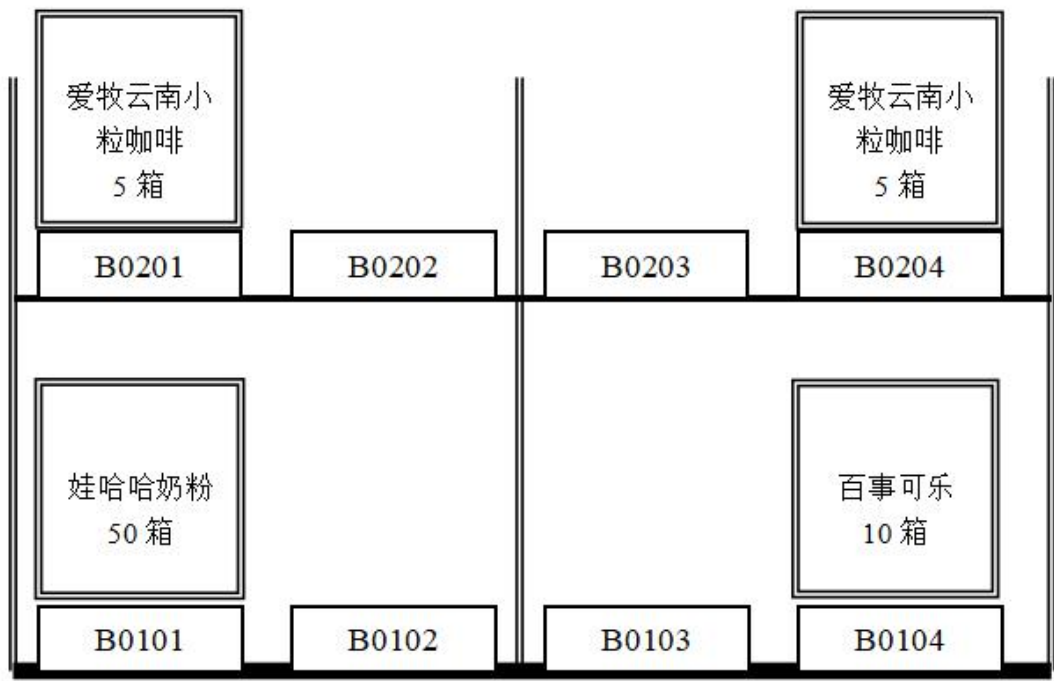

产品运输单

○

○

○

○

○

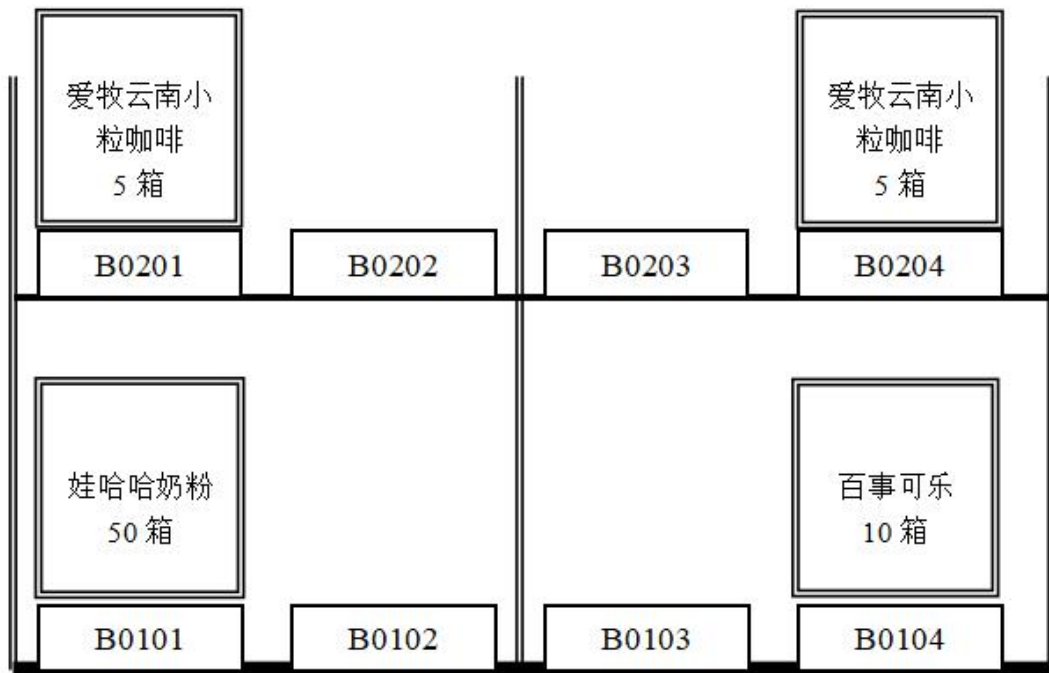

产品运输单



产品运输单

-
-
-
-
-
-
-
-
-

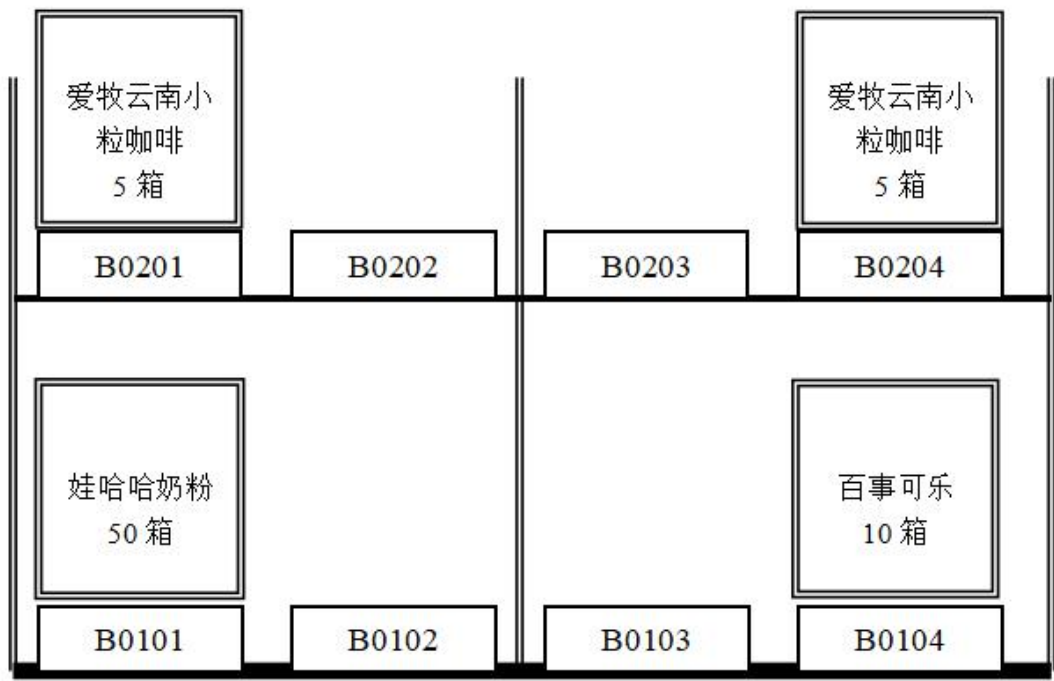

产品运输单

-
-
-
-
-
-
-
-
-

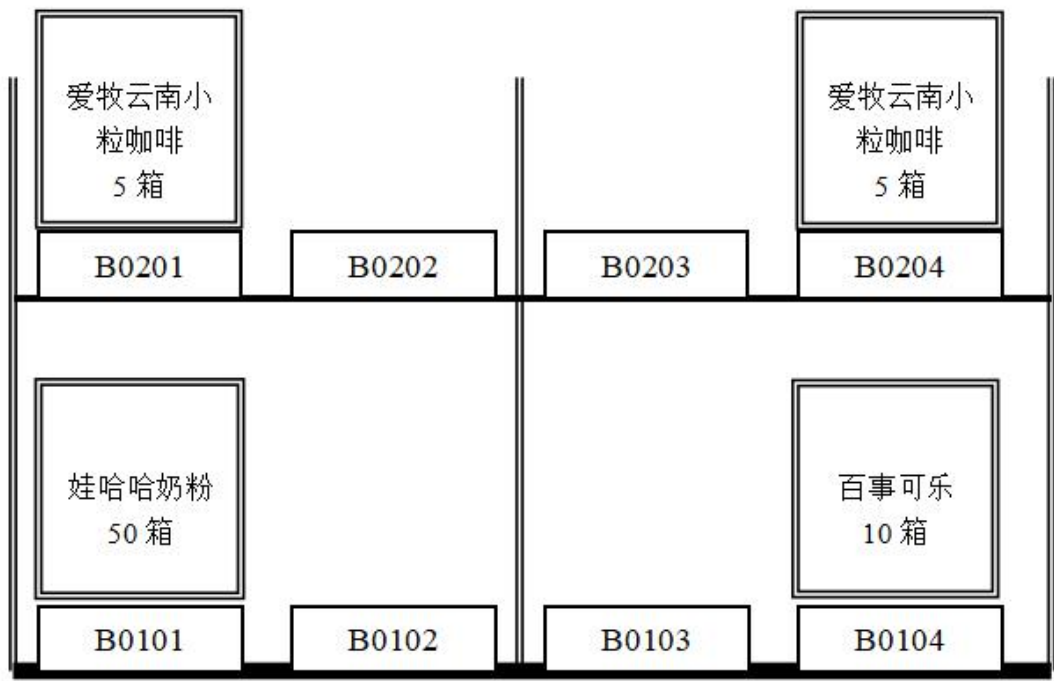

产品运输单

-
-
-
-
-
-
-
-
-

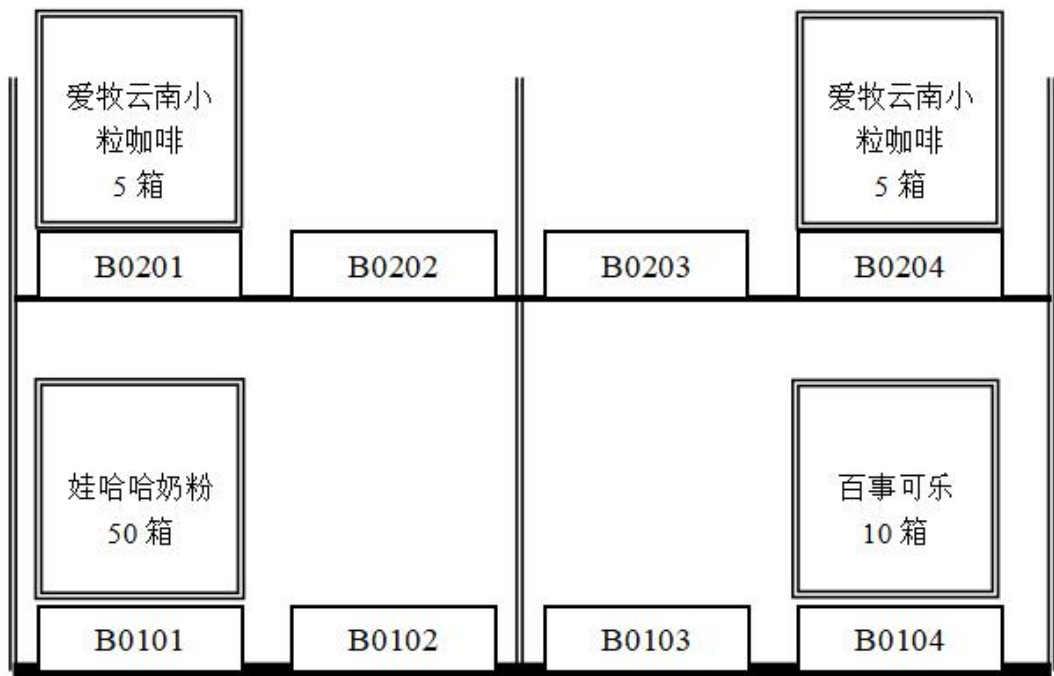

产品运输单

-
-
-
-
-
-
-
-

○

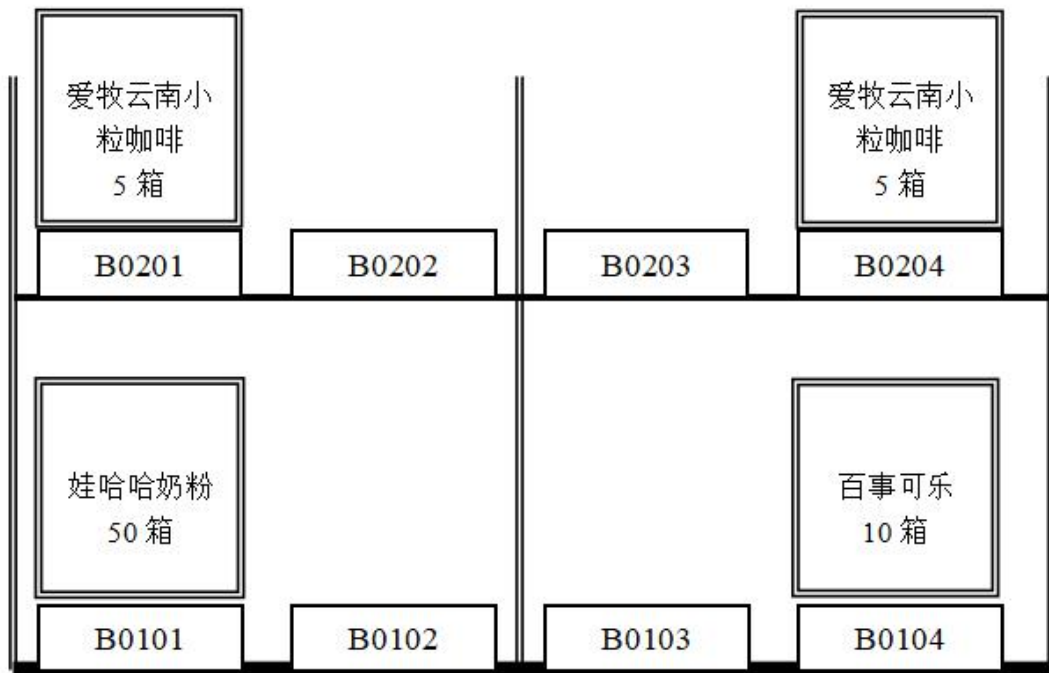



--	--	--	--	--	--

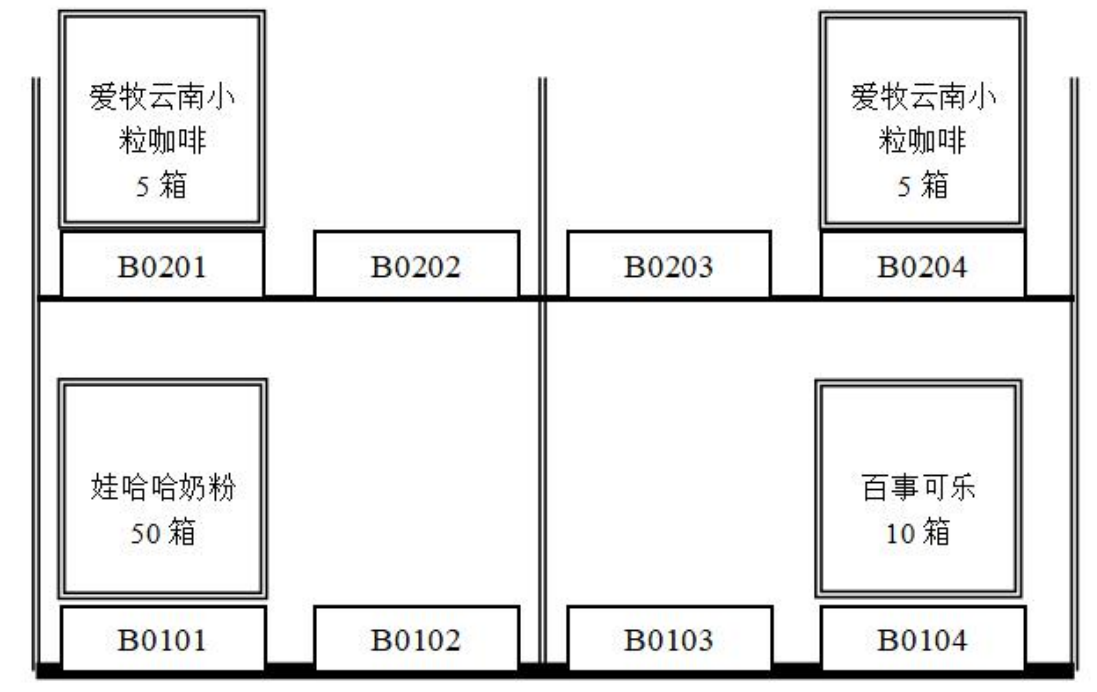

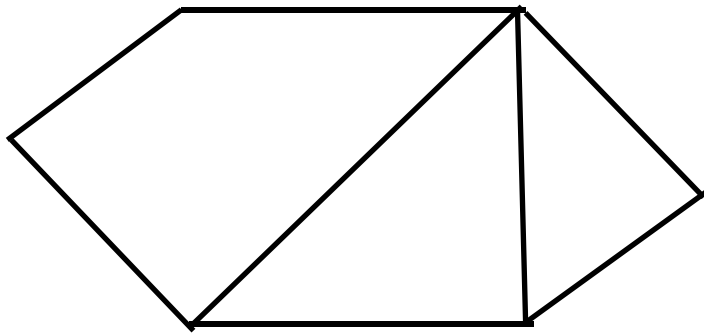

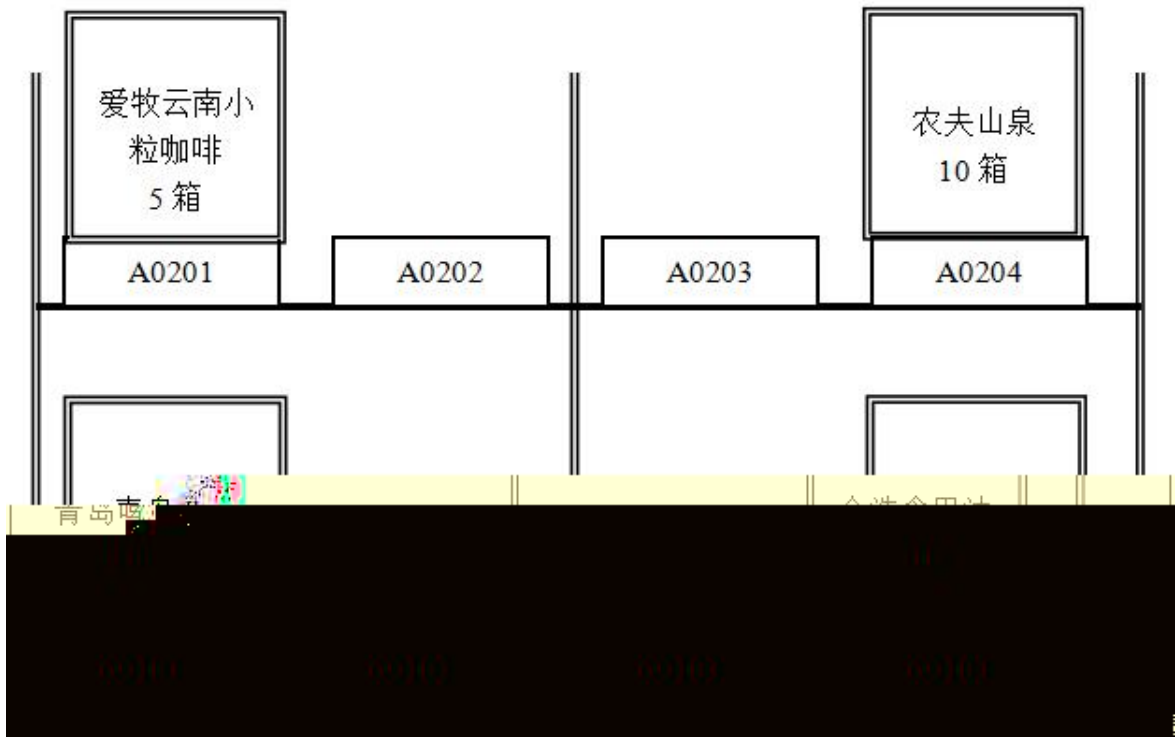



		---	---		

		---	---		

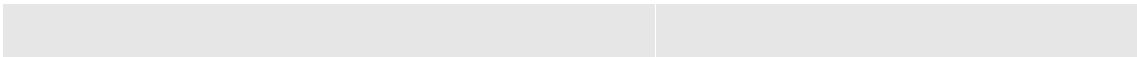



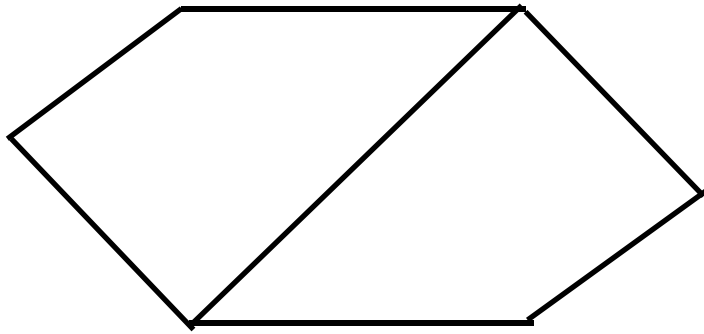

1

--	--	--	--	--	--



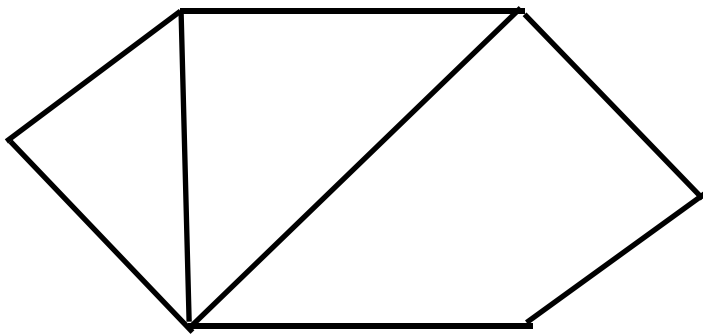

○

○

○

○

○

○

○

○

--	--

○

○

三、国际物流作业组织与管理模块

○



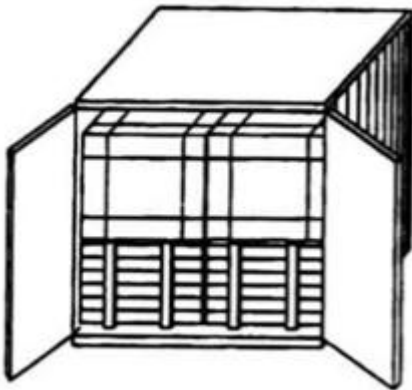
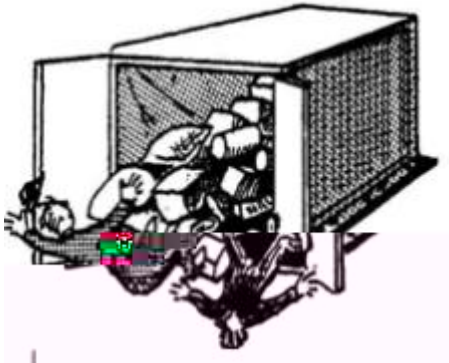
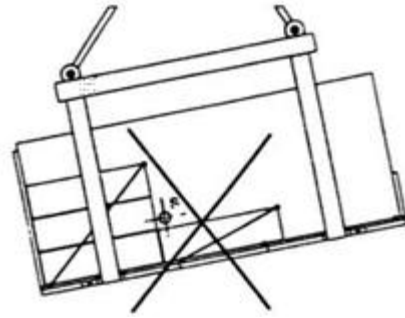

○

船公司 Carrier	船名/航次	服务代码	航线	装船港/卸船港	启-达日期	天	挂港
			Lane	Load/Unload Port	ETD-ETA		Day
船公司	MSC 地中海航运	MASTER 409E	中国-香港台	HONG KONG 香港 KAOHSIUNG 高雄	02/25 (二) 03/15 (六)		18
船公司	NYK 日本邮船	ITALIAN EXPRES S/024	中国-东南亚	HONG KONG 香港 BANGKOK 曼谷	02/25 (二) 03/02 (日)		5
船公司	CMA-CGM 达飞轮船	CMA CGM GEMINI VERA49E	中国-非洲	XIAMEN 厦门 DURBAN 德班	02/25 (二) 03/07 (四)		30
船公司	KLINE 怡和	RYUNDAI PLATINUM M/004Y	中国-中远	SHANGHAI 上海 PANAMA 巴拿马	02/25 (二) 04/09 (三)		43
船公司	EMS 德忌利士	COSCO KAOHSIUNG S/0294E	中国-澳新	HONG KONG 香港 NOUMEA 努美阿	02/25 (二) 04/02 (三)		36
船公司	RGL 招商局	NOTA PERMASAN VPM114	中国-中东 波斯湾 印度	QINGDAO 青岛 MADRAS 马德拉斯	02/28 (五) 03/18 (二)		18
船公司	ZIM 以星	KUD HUNG 311	中国-香港台	NINGBO 宁波 HONG KONG 香港	02/25 (二) 03/15 (六)		18
船公司	SAPMARINE 比利时船	HEIRE P 1404	中国-非洲	KAOHSIUNG 高雄 MINDELO	02/25 (二) 04/03 (一)		39
船公司	CSAV 长荣	CAP SAN NICOLA S/01409	中国-中远	SHANGHAI 上海 RIO GRANDE 里奥格兰德	02/25 (二) 04/07 (一)		41
船公司	OOCL 东方海外	DRESDEN EXPRESS S/1880B	Pacific Atl antic (PAC)	SHANGHAI 上海 HALIFAX 哈利法克斯	02/25 (二) 04/14 (一)		48

○
○

BEIJING	CN		BJS
Y. RENMINBI	CNY		KGS
BOSTON	¥ 1000000	1000000	138000
		1000000	138000
		1000000	138000
		1000000	138000
		1000000	138000
		1000000	138000

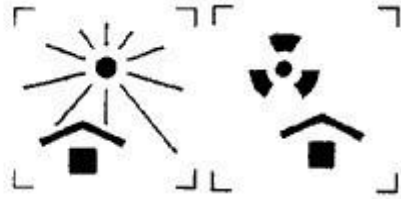
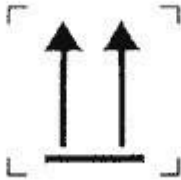
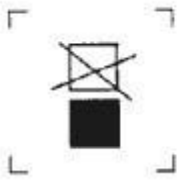

○

○

○

集装箱设备交接单
EQUIPMENT INTERCHANGE RECEIPT

OUT 出场

No.

用箱人/运箱人(CNTR. USER/HAULIER)				提箱地点(PLACE OF DELIVERY)			
发往地点(DELIVERED TO)				返回/收箱地点(PLACE OF RETURN)			
船名/航次(VESSEL/VOYAGE No.)				集装箱号(CNTR. No.)		尺寸/类型(SIZE/TYPER)	
船单号(B/L No.)				危险品类别(IMCO CLASS)		箱封号(SEAL No.)	
免费期限(FREE TIME PERIOD)				承运工具牌号(TRUCK WAGON BARGE No.)			
货重(CARGO W.)		出场目的/状态(PPS OF GATE-OUT/STATUS)		进场目的/状态(PPS OF GATE-IN/STATUS)		出场日期(TIME-OUT)	
						月 日 时	
出场检查记录(INSPECTION AT THE TIME OF INTERCHANGE)							
普通集装箱(GP. CNTR.)		冷藏集装箱(RC. CNTR.)		特种集装箱(SPL. CNTR.)		发电机(GEN. SET)	
<input type="checkbox"/> 正常(SOUND)	<input type="checkbox"/> 异常(DEFFECTIVE)	<input type="checkbox"/> 正常(SOUND)	<input type="checkbox"/> 异常(DEFFECTIVE)	<input type="checkbox"/> 正常(SOUND)	<input type="checkbox"/> 异常(DEFFECTIVE)	<input type="checkbox"/> 正常(SOUND)	<input type="checkbox"/> 异常(DEFFECTIVE)
记录记录及代号(DATA RECORDING CODE)		记录记录及代号(DATA RECORDING CODE)		记录记录及代号(DATA RECORDING CODE)		记录记录及代号(DATA RECORDING CODE)	



--	--	--	--	--	--

--	--	--

--	--	--	--	--	--

--	--	--	--	--	--

--	--	--	--	--	--	--	--

○

WILKINS

○	■ ■

□

	<i>* /</i>	

○

--	--	--

--	--	--	--	--	--

○

○

○

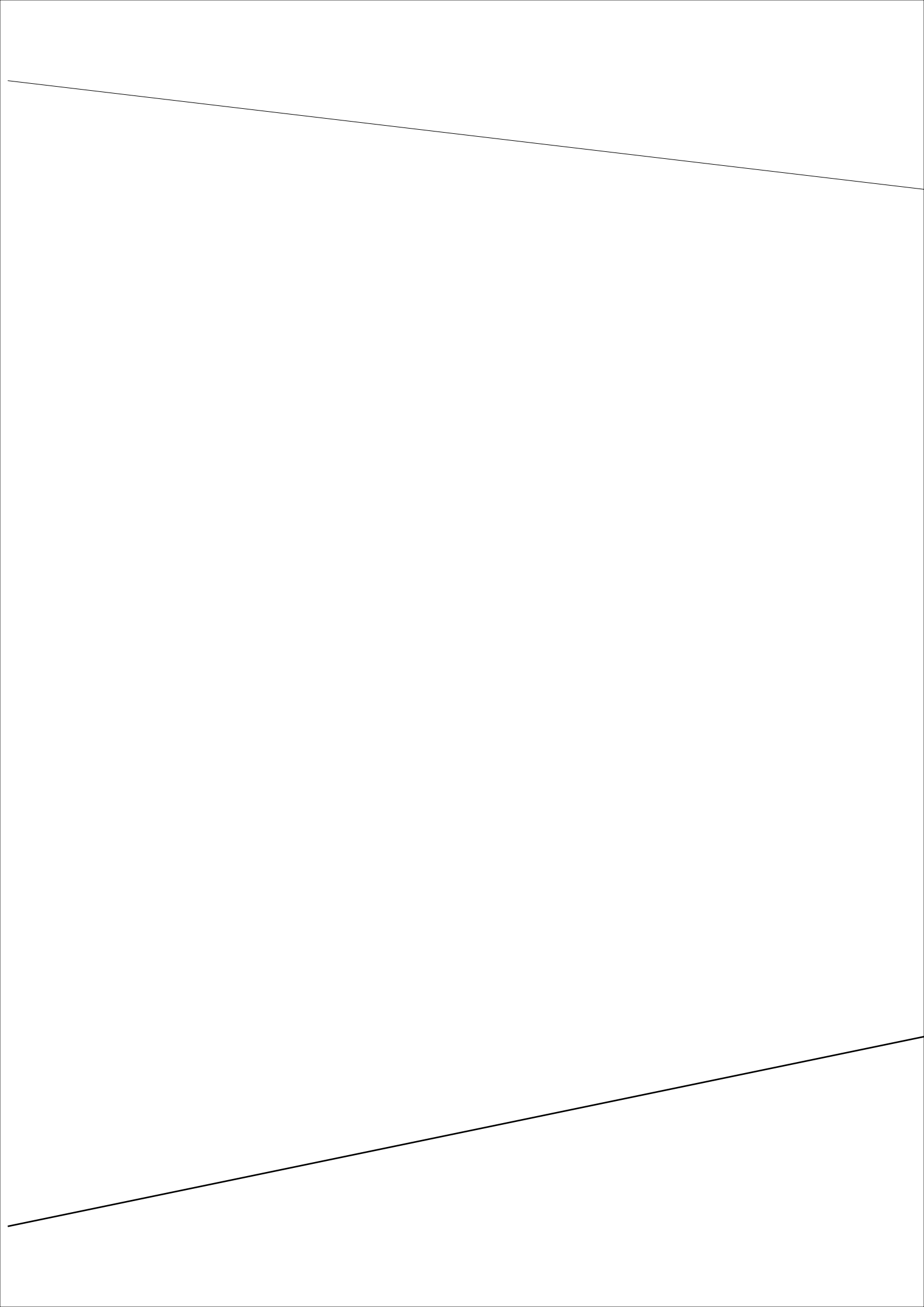

○

四、 快递物流作业组织与管理模块

--	--	--	--	--	--

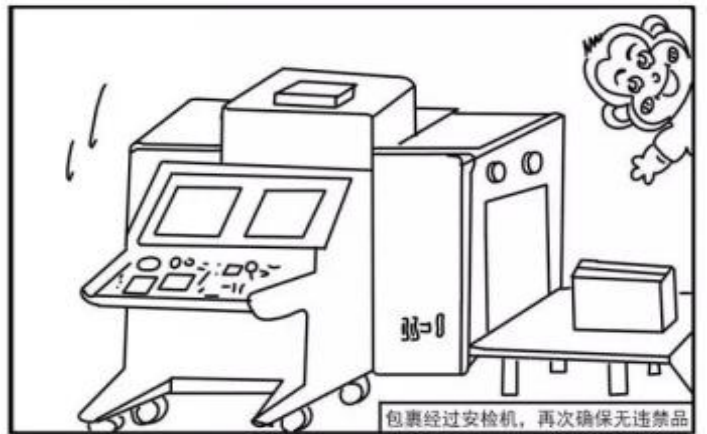

--	--	--	--	--	--

К

В

--	--	--	--	--	--

[想知道:中国成都理工大学校园快递具体在哪? 百度知道](#)

3个回答 - 提问时间: 2014年02月10日

最佳答案  均在银杏后面。宝盒、圆通、顺丰在电影院后面。中通、申通在图书馆下面。常用的是这几个。

zhidao.baidu.com/link?... 2014-02-15 - 百度快照 - 80%好评

--	--	--	--

--	--	--	--

<hr/>
